

# FLAT SWIVEL UNITS

## SERIES DES

### ▶ PRODUCT ADVANTAGES

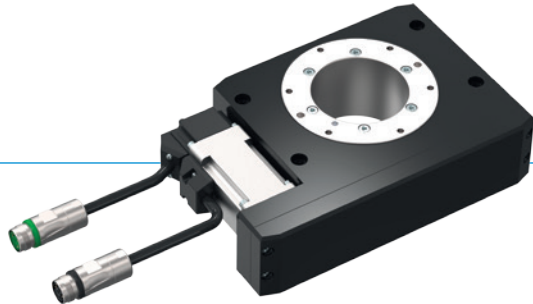

#### “The unique”

##### ▶ **Decide for yourself!**

With the standard motor or motors from another manufacturer - You decide what harmonises the best with your system

##### ▶ **Integrated media transmission**

The D1 media exchanger makes cable breaks and undefined interference contours through the power supply line a thing of the past

##### ▶ **Freely positionable**

No matter whether your task involves rotating, lifting or cycling: The unit is universally usable and can be uniquely adjusted to your application

### ▶ BENEFITS IN DETAIL

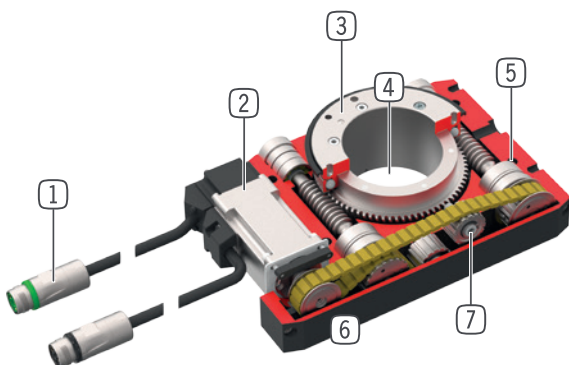

#### ① **Energy supply**

- motor cable, female
- encoder cable, male

#### ② **Drive**

- AC servo motor

#### ③ **Intake flange**

- for connection to application-specific adapter plate (to be produced by the customer)
- simple tool connection

#### ④ **Central bore**

- for cable feed-through

#### ⑤ **Mounting and positioning**

- mounting possible from several sides for versatile positioning

#### ⑥ **Robust, lightweight housing**







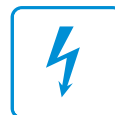





- Hard-coated aluminum alloy

#### ⑦ **Force transfer**

- tooth belt/gear rack/worm gear



## ► SERIES CHARACTERISTICS

Installation size		Version		
DESXXX		-B	D1-B	-99
 <b>PB</b>	Profibus	•	•	
 <b>PN</b>	Profinet, EtherCat, EtherNet/IP, Sercos	•	•	
 <b>M</b>	with drive	•	•	
 <b>X</b>	unpowered; installation provided by customer			•
 <b>5 Mio</b>	5 million maintenance-free revolutions (max.)	•	•	•
 <b>L</b>	Self locking mechanism	•	•	•
 <b>IP 54</b>	IP54	•	•	•
 <b>S</b>	Integrated sensing	•	•	
 <b>CVP</b>	Continuously variable positions	•	•	
 <b>SA</b>	Adjustable swivel angle	•	•	
 <b>E</b>	Electrical feed-through		•	
 <b>F</b>	Fluid feed-through		•	

## ► TECHNICAL DATA

Installation size	Swivel angle [°]	Torque [Nm]	Weight [kg]	IP class
<b>DES140</b>	∞	10 - 12	4 - 7	IP54
<b>DES190</b>	∞	62 - 64	10,8 - 15,9	IP54

## ► FURTHER INFORMATION IS AVAILABLE ONLINE



All information just a click away at: [www.zimmer-group.com](http://www.zimmer-group.com). Find data, illustrations, 3D models and operating instructions for your installation size using the order number for your desired product. Quick, clear and always up-to-date.

# FLAT SWIVEL UNITS

## INSTALLATION SIZE DES140D1

### ▶ PRODUCT SPECIFICATIONS



#### ▶ Forces and moments

Indicates the static load on the bearing.

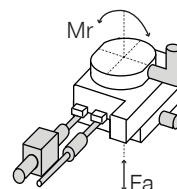

Fa [N]	7000
Mr [Nm]	400

### ▶ INCLUDED IN DELIVERY



1 [piece]  
Commissioning USB  
052650

### ▶ RECOMMENDED ACCESSORIES



#### ENERGY SUPPLY



**ZUBHCS-B**  
Drive controller Profibus



**ZUBHCSME-B**  
Drive control unit SERCOS III, PROFINET IO, EtherNet/IP, EtherCAT



**ZUBHCSN**  
Line filter



#### CONNECTIONS / OTHER



**ZUBHCSKAP01**  
Programming cable



**ZUBHCSKAL05-B**  
Power cable 5 m



**ZUBHCSKAL10-B**  
Power cable 10 m



**ZUBHCSKAL25-B**  
Power cable 25 m



#### CONNECTIONS / OTHER



**ZUBHCSS**  
Indra Works Drive Start Up CD



**ZUBHCSKAG05-B**  
Encoder cable 5 m



**ZUBHCSKAG10-B**  
Encoder cable 10 m



**ZUBHCSKAG25-B**  
Encoder cable 25 m



**RSTVSM23G12B-B**  
Round plug, straight - M23 socket



**RSTVSM23W12B-B**  
Round plug, angular - M23 socket



**RSTVSM23G12S-B**  
Round plug, straight - M23 plug



**RSTVSM23W12S-B**  
Round plug, angular - M23 plug

Order no.	► Technical data	
	DES140D1-B	DES140D1-99
Drive *	AC servo motor	Specific to the customer
Rotation angle [°]	unlimited	
Nominal torque [Nm]	7	
Torque max. [Nm]	10	
Nominal speed [rpm]	30	
Max. speed [rpm]	50	
Swivel time 360° with 30 rpm [s] **	2.5	
Swivel time 360° with 50 rpm [s] **	1.8	
Moment of inertia max. [kg m <sup>2</sup> ]	1	
Jaw speed in positioning mode [rad/s <sup>2</sup> ]	50	
Positioning delay [rad/s <sup>2</sup> ]	50	
Electrical energy transfer	12x2A / 12x120V DC	12x2A / 12x120V DC
Pneumatic energy transfer [Quantity]	1	1
Self locking mechanism	Helical gear / worm gear	Helical gear / worm gear
Power transfer	Helical gear / worm gear	Helical gear / worm gear
Repetition accuracy +/- [°]	0.1	0.1
Operating temperature [°C]	5 ... +80	5 ... +80
Net input voltage	1x200-240 VAC 50HZ	
Continuous current [A]	0.9	
Peak current [A]	3	
Protection to IEC 60529	IP54	IP54
Weight [kg]	7	6.8

\* Select the third-party motor corresponding to the motor performance figures in the DES series - Accessories chapter

\*\* Swivel time does not depend on the moment of inertia (the maximum moment of inertia must not be exceeded)

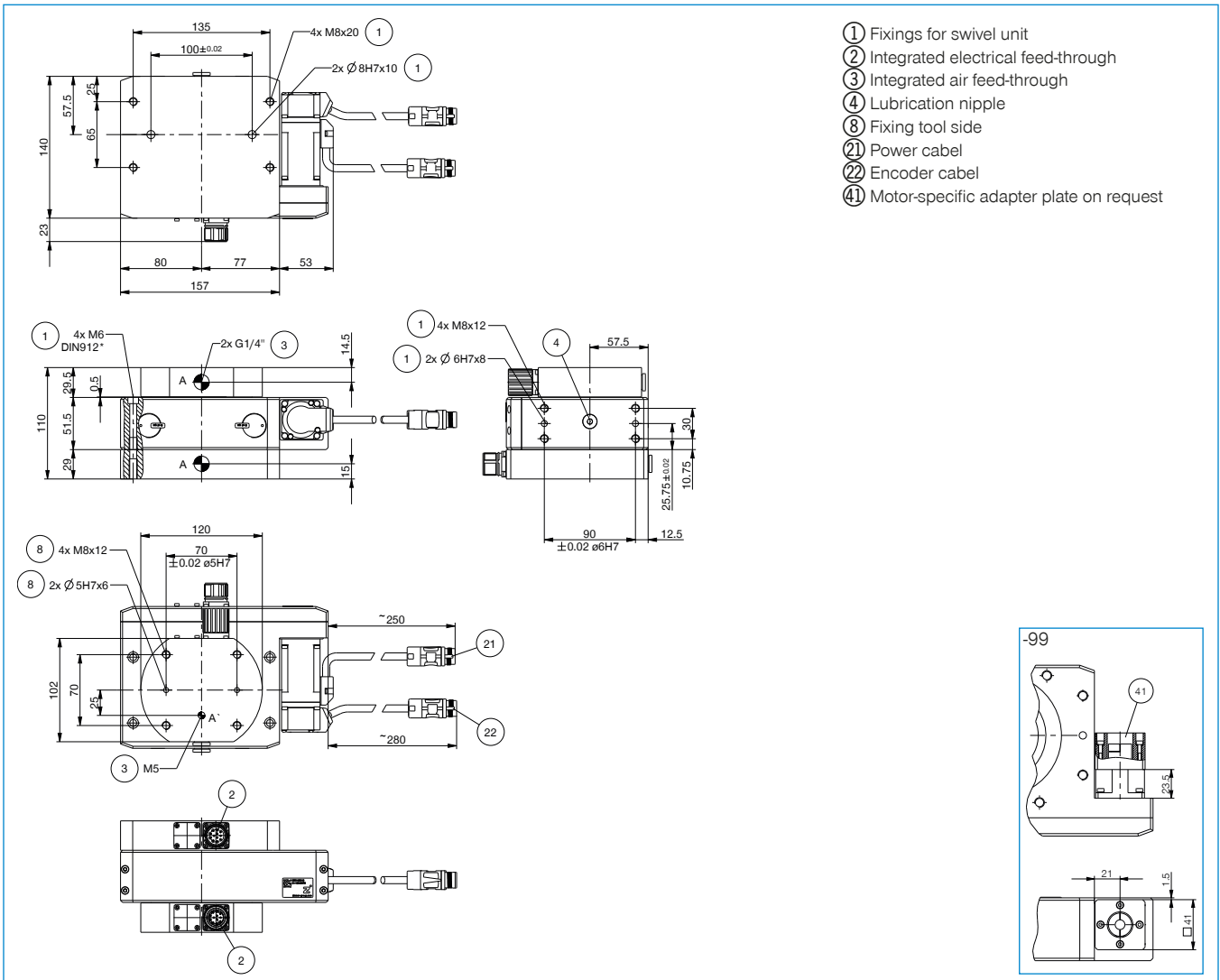

# FLAT SWIVEL UNITS

## DES SERIES - ACCESSORIES

### ▶ RECOMMENDED ACCESSORIES



#### ENERGY SUPPLY



**ZUBHCS-B**  
Drive controller Profibus



**ZUBHCSME-B**  
Drive control unit SERCOS III, PROF-INET IO, EtherNet/IP, EtherCAT



**ZUBHCSN**  
Line filter



**GV1-4X8**  
Straight Fittings - Quick Connect Style



**WV1-4X8**  
Angled Fittings - Quick Connect Style



#### CONNECTIONS / OTHER

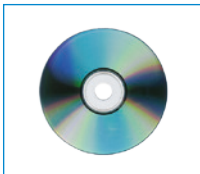

**ZUBHCSS**  
Indra Works Drive Start Up CD



**ZUBHCSKAG05-B**  
Encoder cable 5 m



**ZUBHCSKAG10-B**  
Encoder cable 10 m



**ZUBHCSKAG25-B**  
Encoder cable 25 m



**ZUBHCSKAP01**  
Programming cable



**ZUBHCSKAL05-B**  
Power cable 5 m



**ZUBHCSKAL10-B**  
Power cable 10 m



**ZUBHCSKAL25-B**  
Power cable 25 m



**RSTVSM23G12S-B**  
Round plug, straight - M23 plug



**RSTVSM23W12S-B**  
Round plug, angular - M23 plug



**RSTVSM23G12B-B**  
Round plug, straight - M23 socket



**RSTVSM23W12B-B**  
Round plug, angular - M23 socket

► **Technical data for motors**

Order no.	MSM019B-0300-NN-M5-MH0	MSM031C-0300-NN-M5-MH0
compatible with	DES140	DES190
Manufacturer	BOSCH	BOSCH
Nominal torque [Nm]	0,32	1,3
Torque max. [Nm]	0,95	3,8
Nominal speed [rpm]	3000	3000
Max. speed [rpm]	5000	5000
Protection to IEC 60529	IP54	IP54

