

2-JAW PARALLEL GRIPPERS WITH LONG STROKE SERIES GH6000

▶ PRODUCT ADVANTAGES

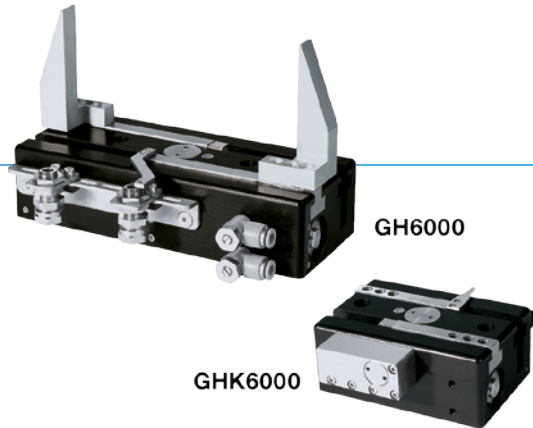

“The robust”

- ▶ **Gripper jaws may be up to 25% longer in comparison to the benchmark**

The highest force and torque measurement enables flexible for maximum dynamics

- ▶ **Over 30% more powerful than the benchmark**





Optimisation of weight and force reduces your application costs since all components can have a smaller scale

- ▶ **Failure-free continuous operation**

Our uncompromising “Made in Germany” quality guarantees up to 10 million maintenance-free cycles

- ▶ **Securing the workpiece in case of drop in pressure above clamping element on the condition of a positive gripper jaw design (only for variant GHK)**

▶ SERIES CHARACTERISTICS

	Installation size / Variant	
	GH60XX	GHK60XX
 Position maintenance by means of clamping element		•
 10 million maintenance-free cycles (max.)	•	•
 Inductive sensor	•	•
 Magnetic field sensor	•	•
 IP40	•	•



► BENEFITS IN DETAIL

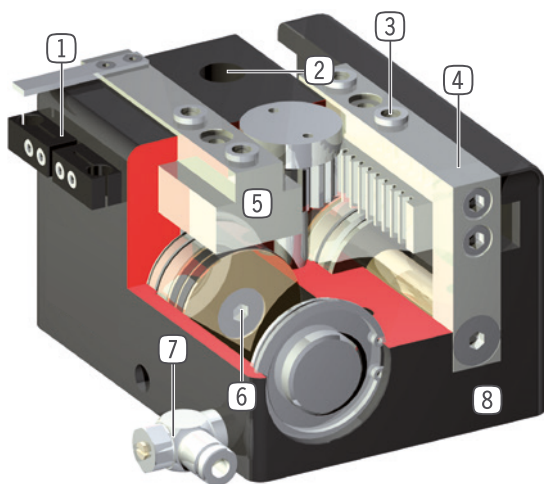

- ① **Mounting block**
 - mounting for inductive proximity switch
- ② **Mounting and positioning**
 - mounting possible from several sides for versatile positioning
- ③ **Removable centering sleeves**
 - quick and economical positioning of the gripper fingers
- ④ **Gripper jaw**
 - individual gripper finger mounting
- ⑤ **Precise long T-Slot guides**
 - high forces and moments capacity
- ⑥ **Drive**
 - two double-acting pneumatic cylinders
 - synchronized by gearwheel
- ⑦ **Energy supply**
 - possible from several sides
 - CAUTION: always operate long stroke gripper with supplied exhaust air flow control valve (speed regulation)
- ⑧ **Robust, lightweight housing**
 - Hard-coated aluminum alloy

► TECHNICAL DATA

Installation size	Stroke per jaw [mm]	Gripping force [N]	Weight [kg]	IP class
GH6000	20 - 80	120 - 155	0,3 - 0,75	IP40
GH6100	40 - 80	370 - 530	1,5 - 2,2	IP40
GH6200	40 - 150	900 - 1400	3,3 - 7,5	IP40
GH6300	60 - 150	1520 - 2270	7 - 10,5	IP40
GH6400	60 - 200	2600 - 3400	10,4 - 22,7	IP40

► FURTHER INFORMATION IS AVAILABLE ONLINE



All information just a click away at: www.zimmer-group.com. Find data, illustrations, 3D models and operating instructions for your installation size using the order number for your desired product. Quick, clear and always up-to-date.

2-JAW PARALLEL GRIPPERS WITH LONG STROKE

INSTALLATION SIZE GH6460

▶ PRODUCT SPECIFICATIONS

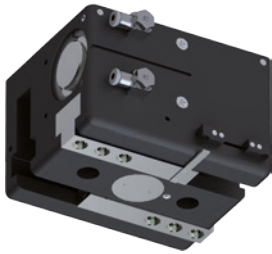

▶ Gripping force diagram

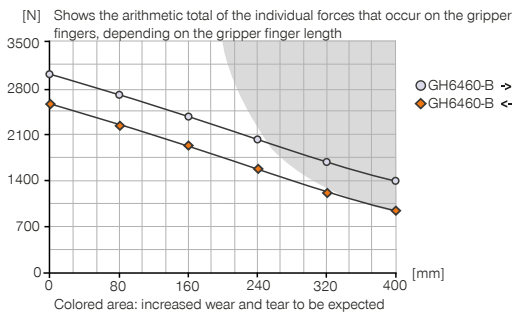

▶ Forces and moments

Displays static forces and moments that can also have an effect, besides the gripping force.



Mr [Nm]	250
Mx [Nm]	300
My [Nm]	200
Fa [N]	9000

▶ INCLUDED IN DELIVERY



2 [piece]
Mounting block
KB8-28



4 [piece]
Centering Disc
DST42000



2 [piece]
Flow Control Valves - with Swivel joint
DRV1-4X8

▶ YOU CAN FIND RECOMMENDED ACCESSORIES ON THE FOLLOWING PAGES

Order no.	► Technical data	
	GH6460-B	GHK6460
Stroke per jaw [mm]	60	60
Gripping force in closing [N]	3000	3000
Gripping force in opening [N]	2600	2600
Retention force in case of drop in pressure [N]		1050
Closing time [s]	0.4	0.4
Opening time [s]	0.4	0.4
Permissible weight per jaw max [kg]	6	6
Length of the gripper fingers max. [mm]	400	400
Repetition accuracy +/- [mm]	0.05	0.05
Operating pressure min. [bar]	3	3
Operating pressure max. [bar]	8	8
Nominal operating pressure [bar]	6	6
Operating temperature min. [°C]	5	5
Operating temperature max. [°C]	+80	+80
Air volume per cycle [cm ³]	710	710
Weight [kg]	10.4	11.5

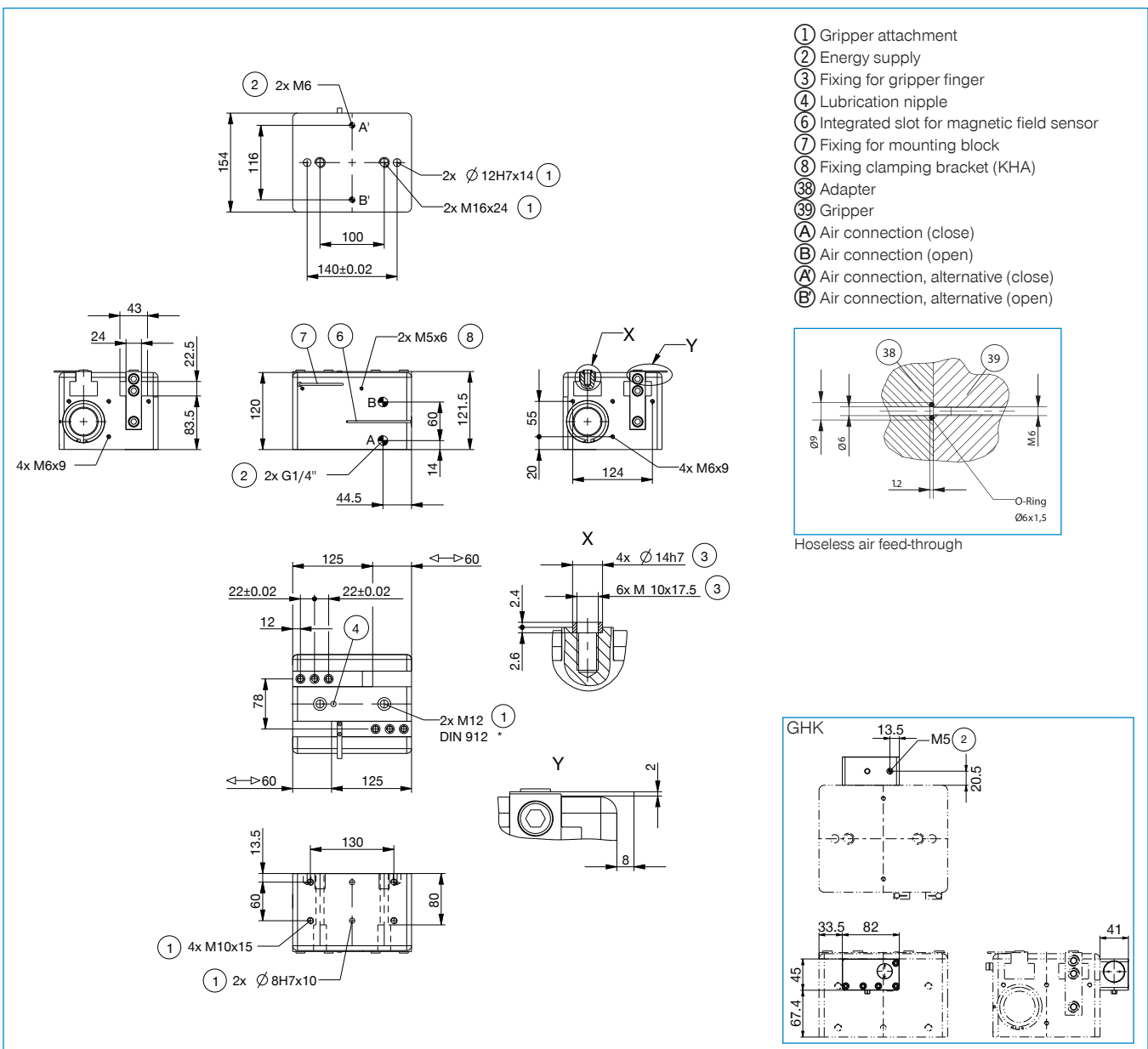

2-JAW PARALLEL GRIPPERS WITH LONG STROKE SERIES GH6000 - ACCESSORIES

▶ ACCESORIES

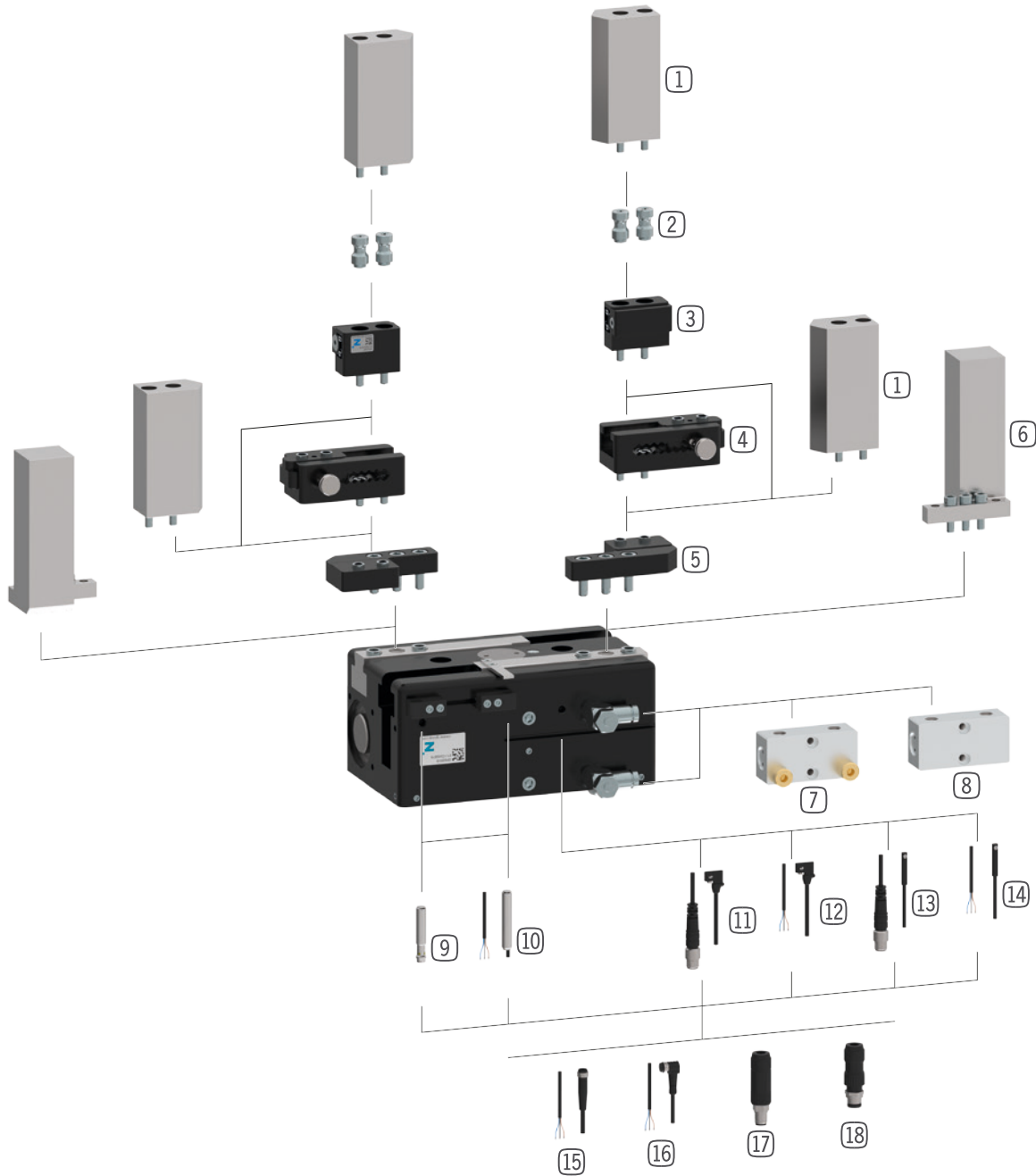

▶ RECOMMENDED ACCESSORIES GH6000

Pos.	Order no.	Accessories
①	UB5004AL	* Universal jaw aluminium
①	UB5004ST	* Universal jaw steel
②	WB5004L	* Changeable jaw, loose-part-set
③	WB5004F	* Changeable jaw, fix-part
④	EB5004ST	* Steel adjustment jaw
④	EB5004AL	* Aluminum adjustment jaw
⑤	APGH6000	Adapter plate
⑥	UB6000-B	Universal jaw set aluminium
⑦	DSV1-8E	Pressure safety valve with quick exhaust
⑧	DSV1-8	Pressure safety valve

*in conjunction with pos. ⑤

Pos.	Order no.	Accessories
⑨	NJ6.5-E2S	** Inductive proximity switch - Connector M8
⑩	NJ6.5-E2-01	** Inductive proximity switch - Cable 5 m
⑪	MFS01-S-KHC-P1-PNP	Magnetic field sensor angled, cable 0.3 m - M8 connector
⑫	MFS01-K-KHC-P1-PNP	Magnetic field sensor angled, cable 5 m
⑬	MFS02-S-KHC-P1-PNP	Magnetic field sensor straight, cable 0.3 m - M8 connector
⑭	MFS02-K-KHC-P1-PNP	Magnetic field sensor straight, cable 5 m
⑮	KAG500	Plug-in connector Straight Cable 5m - Socket M8 (female)
⑯	KAW500	Plug-in connector Angled Cable 5m - Socket M8 (female)
⑰	S8-G-3	Plug-in connector customizable Straight - Connector M8
⑱	S12-G-3	Plug-in connector customizable Straight - Connector M12

** not with GH6020

▶ RECOMMENDED ACCESSORIES GH6100

Pos.	Order no.	Accessories
①	UB5006AL	* Universal jaw aluminium
①	UB5006ST	* Universal jaw steel
②	WB5006L	* Changeable jaw, loose-part-set
③	WB5006F	* Changeable jaw, fix-part
④	EB5006ST	* Steel adjustment jaw
④	EB5006AL	* Aluminum adjustment jaw
⑤	APGH6100	Adapter plate
⑥	UB6100-B	Universal jaw set aluminium
⑦	DSV1-8E	Pressure safety valve with quick exhaust
⑧	DSV1-8	Pressure safety valve

*in conjunction with pos. ⑤

Pos.	Order no.	Accessories
⑨	NJ8-E2S	Inductive proximity switch - Connector M8
⑩	NJ8-E2	Inductive proximity switch - Cable 5 m
⑪	MFS01-S-KHC-P1-PNP	Magnetic field sensor angled, cable 0.3 m - M8 connector
⑫	MFS01-K-KHC-P1-PNP	Magnetic field sensor angled, cable 5 m
⑬	MFS02-S-KHC-P1-PNP	Magnetic field sensor straight, cable 0.3 m - M8 connector
⑭	MFS02-K-KHC-P1-PNP	Magnetic field sensor straight, cable 5 m
⑮	KAG500	Plug-in connector Straight Cable 5m - Socket M8 (female)
⑯	KAW500	Plug-in connector Angled Cable 5m - Socket M8 (female)
⑰	S8-G-3	Plug-in connector customizable Straight - Connector M8
⑱	S12-G-3	Plug-in connector customizable Straight - Connector M12

▶ RECOMMENDED ACCESSORIES GH6200

Pos.	Order no.	Accessories
①	UB5008AL	* Universal jaw aluminium
①	UB5008ST	* Universal jaw steel
②	WB5008L	* Changeable jaw, loose-part-set
③	WB5008F	* Changeable jaw, fix-part
④	EB5008ST	* Steel adjustment jaw
④	EB5008AL	* Aluminum adjustment jaw
⑤	APGH6200	Adapter plate
⑥	UB6200-B	Universal jaw set aluminium
⑦	DSV1-8E	Pressure safety valve with quick exhaust
⑧	DSV1-8	Pressure safety valve

*in conjunction with pos. ⑤

Pos.	Order no.	Accessories
⑨	NJ8-E2S	Inductive proximity switch - Connector M8
⑩	NJ8-E2	Inductive proximity switch - Cable 5 m
⑪	MFS01-S-KHC-P1-PNP	Magnetic field sensor angled, cable 0.3 m - M8 connector
⑫	MFS01-K-KHC-P1-PNP	Magnetic field sensor angled, cable 5 m
⑬	MFS02-S-KHC-P1-PNP	Magnetic field sensor straight, cable 0.3 m - M8 connector
⑭	MFS02-K-KHC-P1-PNP	Magnetic field sensor straight, cable 5 m
⑮	KAG500	Plug-in connector Straight Cable 5m - Socket M8 (female)
⑯	KAW500	Plug-in connector Angled Cable 5m - Socket M8 (female)
⑰	S8-G-3	Plug-in connector customizable Straight - Connector M8
⑱	S12-G-3	Plug-in connector customizable Straight - Connector M12

▶ RECOMMENDED ACCESSORIES GH6300

Pos.	Order no.	Accessories
①	UB5010ST	* Universal jaw steel
①	UB5010AL	* Universal jaw aluminium
②	WB5010L	* Changeable jaw, loose-part-set
③	WB5010F	* Changeable jaw, fix-part
④	EB5010ST	* Steel adjustment jaw
④	EB5010AL	* Aluminum adjustment jaw
⑤	APGH6300	Adapter plate
⑦	DSV1-8E	Pressure safety valve with quick exhaust
⑧	DSV1-8	Pressure safety valve
⑨	NJ8-E2S	Inductive proximity switch - Connector M8

*in conjunction with pos. ⑤

Pos.	Order no.	Accessories
⑩	NJ8-E2	Inductive proximity switch - Cable 5 m
⑪	MFS01-S-KHC-P1-PNP	Magnetic field sensor angled, cable 0.3 m - M8 connector
⑫	MFS01-K-KHC-P1-PNP	Magnetic field sensor angled, cable 5 m
⑬	MFS02-S-KHC-P1-PNP	Magnetic field sensor straight, cable 0.3 m - M8 connector
⑭	MFS02-K-KHC-P1-PNP	Magnetic field sensor straight, cable 5 m
⑮	KAG500	Plug-in connector Straight Cable 5m - Socket M8 (female)
⑯	KAW500	Plug-in connector Angled Cable 5m - Socket M8 (female)
⑰	S8-G-3	Plug-in connector customizable Straight - Connector M8
⑱	S12-G-3	Plug-in connector customizable Straight - Connector M12

▶ RECOMMENDED ACCESSORIES GH6400

Pos.	Order no.	Accessories
①	UB5016ST	* Universal jaw steel
①	UB5016AL	* Universal jaw aluminium
②	WB5016L	* Changeable jaw, loose-part-set
③	WB5016F	* Changeable jaw, fix-part
④	EB5016ST	* Steel adjustment jaw
④	EB5016AL	* Aluminum adjustment jaw
⑤	APGH6400	Adapter plate
⑦	DSV1-8E	Pressure safety valve with quick exhaust
⑧	DSV1-8	Pressure safety valve
⑨	NJ8-E2S	Inductive proximity switch - Connector M8

*in conjunction with pos. ⑤

Pos.	Order no.	Accessories
⑩	NJ8-E2	Inductive proximity switch - Cable 5 m
⑪	MFS01-S-KHC-P1-PNP	Magnetic field sensor angled, cable 0.3 m - M8 connector
⑫	MFS01-K-KHC-P1-PNP	Magnetic field sensor angled, cable 5 m
⑬	MFS02-S-KHC-P1-PNP	Magnetic field sensor straight, cable 0.3 m - M8 connector
⑭	MFS02-K-KHC-P1-PNP	Magnetic field sensor straight, cable 5 m
⑮	KAG500	Plug-in connector Straight Cable 5m - Socket M8 (female)
⑯	KAW500	Plug-in connector Angled Cable 5m - Socket M8 (female)
⑰	S8-G-3	Plug-in connector customizable Straight - Connector M8
⑱	S12-G-3	Plug-in connector customizable Straight - Connector M12

2-JAW PARALLEL GRIPPERS WITH LONG STROKE SERIES GH6000 FUNCTIONAL DESCRIPTION



GRIPPING COMPONENTS

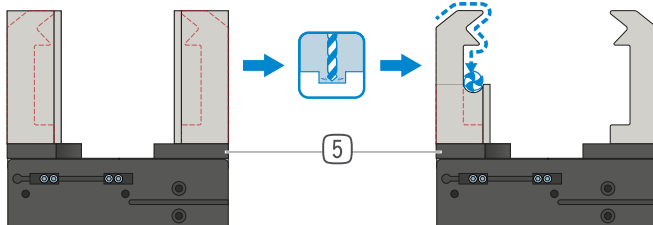

Universal jaws – UB5000

Can be used immediately or for individual reprocessing

The gripper blanks are available in aluminum (AL) and steel (ST) versions and are installed directly on the gripper using the screws in the scope of delivery. The fits for the centering sleeves are already in place for this purpose. One universal jaw is required for each gripper jaw.

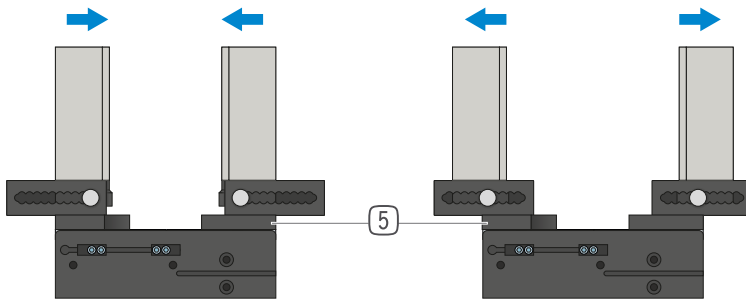

Adjustment jaws – EB5000

For tool-free adaptation of the gripper range

By manually activating the locking mechanism, which is pre-tensioned by a spring, the adjustment jaw can be moved within a grid of detent notches that has a number scale. Depending on the forces and torques that apply, the adjustment jaws are available in aluminum (AL) and steel (ST) versions. One adjustment jaw is required for each gripper jaw.

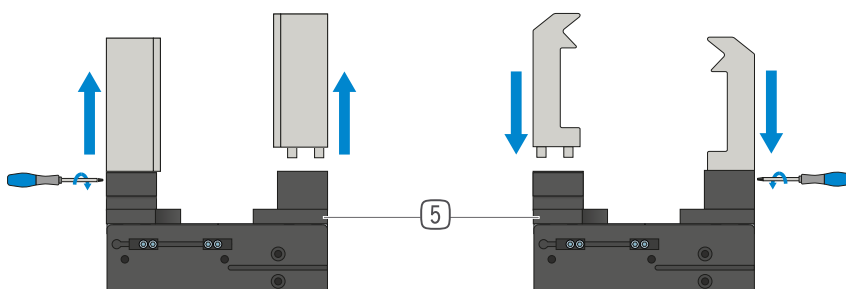

Interchangeable jaws – WB5000

Enable fast change of individual gripper fingers

For each gripper jaw, a fixed part and at least one loose part set is needed, depending on the number of gripper fingers to be changed. Manual locking via the Torx wrench included in the scope of delivery of the fixed part can take place from two sides.



THE GRIPPING COMPONENTS CAN BE COMBINED!

The gripping components listed above can be combined with each other. For connection to the gripper, the adapter plate 5, which is included in the recommended accessories for the gripper, is required.



GRIPPING COMPONENTS

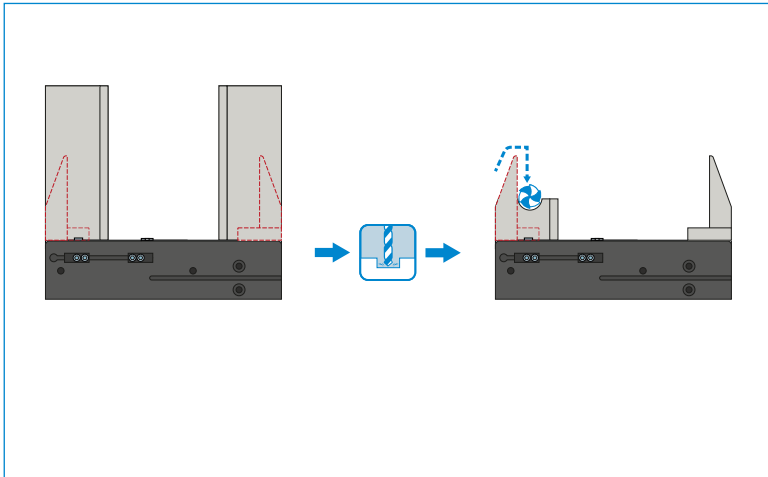

Universal jaws – UB6000-B

Can be used immediately or for individual reprocessing

The gripper blanks are available in an aluminum (AL) version and are installed directly on the gripper using the screws in the scope of delivery. The fits for the centering sleeves are already in place for this purpose. One universal jaw set is required for each gripper.



ENERGY SUPPLY

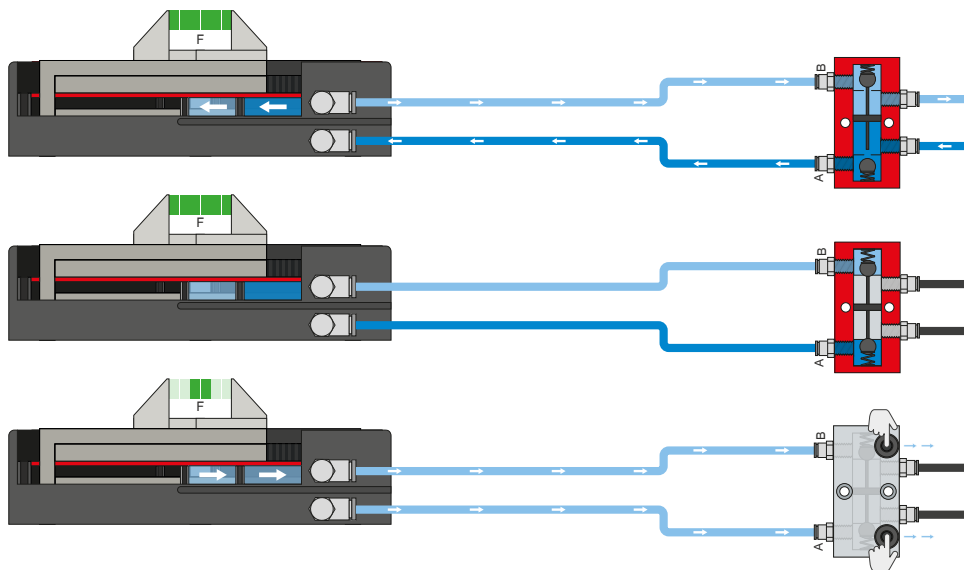

Pressure safety valve – DSV

Ensures safe retention of force and position if the system pressure drops

The integrated double check valve, which can be unlocked, retains the system pressure of the gripper in case of EMERGENCY STOP. To ensure the function, the valve must be installed as close to the gripper's air connection as possible. In variant E, two pushbuttons are installed that allow for controlled bleeding of the gripper.

2-JAW PARALLEL GRIPPERS WITH LONG STROKE SERIES GH6000 FUNCTIONAL DESCRIPTION



SENSORS

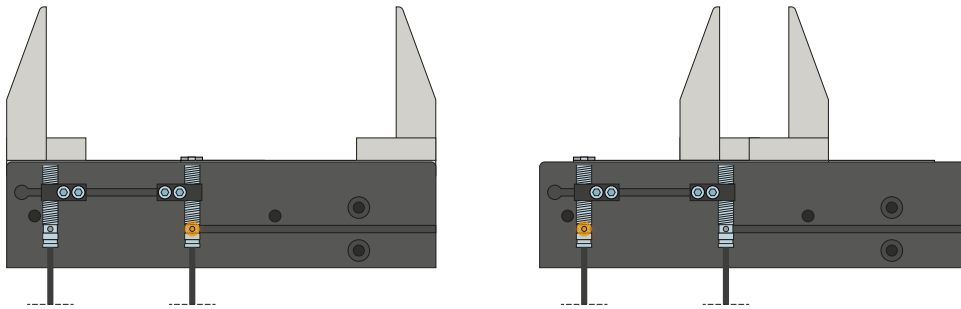

Inductive sensors – NJ

The mounting block is aligned to the cam switch, and the sensor is guided into the mounting block until the required switching distance to the cam switch is reached. Fine adjustment can be made by moving the mounting block again. The sensors are available in versions with 5 m cables with exposed leads and 0,3 m cable with connector, as well as with direct plug orientation.

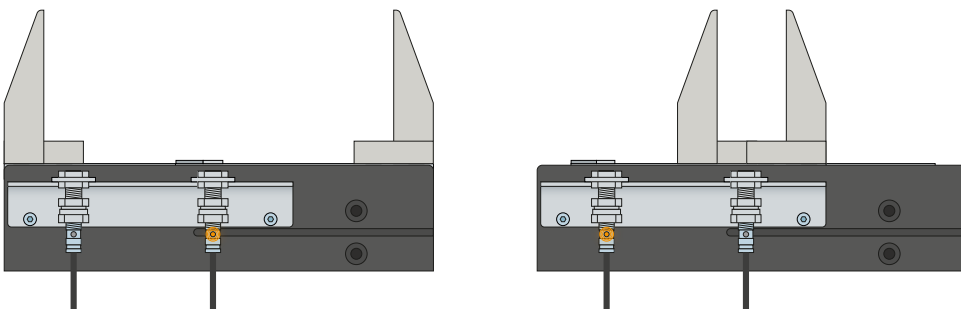

Clamping bracket – KHA

The KHA can be used as an alternative to installing the sensor via the mounting block. The sensor is inserted into the clamping bracket as far as it will go and secured. Tuning to the cam switch then takes place. Fine adjustment can be made by moving the clamping bracket again.



SENSORS

MFS02

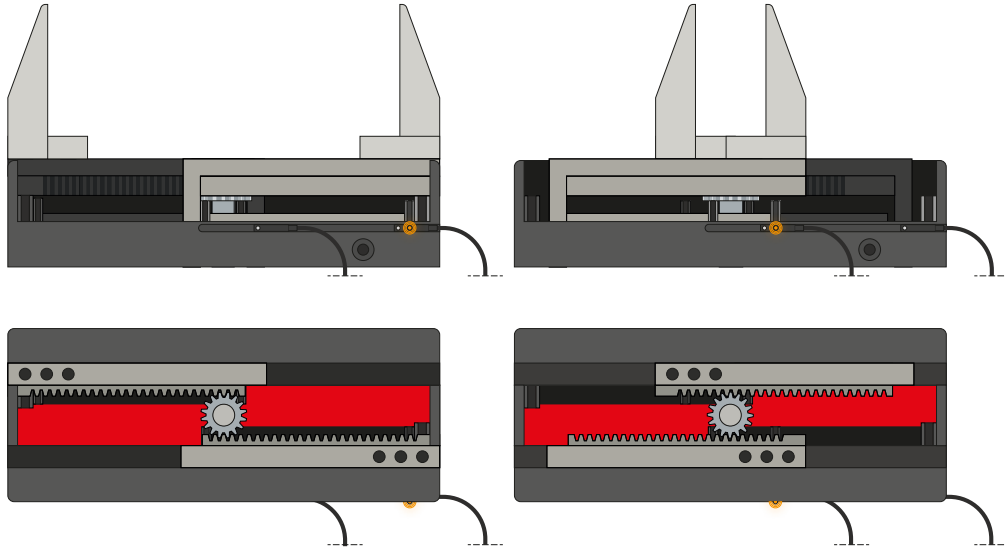

MFS01

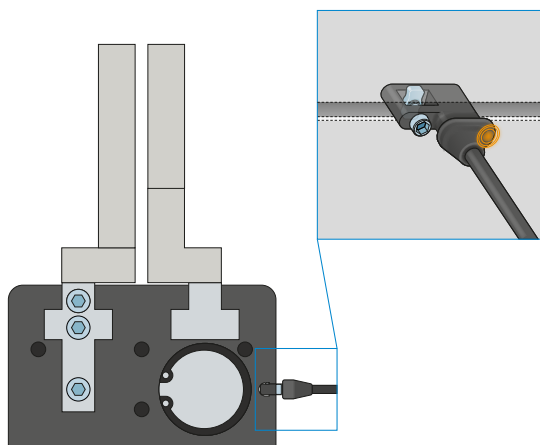

1-point magnetic field sensors – MFS

For non-contact sensing of the piston position

These sensors are installed in the C-groove of the gripper and detect the magnet attached to the piston of the gripper. To ensure use in a wide variety of space conditions, the sensors are available in two variants. While the horizontal MFS02, with straight cable outlet, disappears into the C-groove of the gripper almost completely, the vertical MFS01 is taller, but has a cable outlet that is offset at an angle of 90°. The variants are available in versions with 5 m cables with exposed leads and 0,3 m cable with connector.

2-JAW PARALLEL GRIPPERS WITH LONG STROKE SERIES GH6000 FUNCTIONAL DESCRIPTION



CONNECTIONS / OTHER

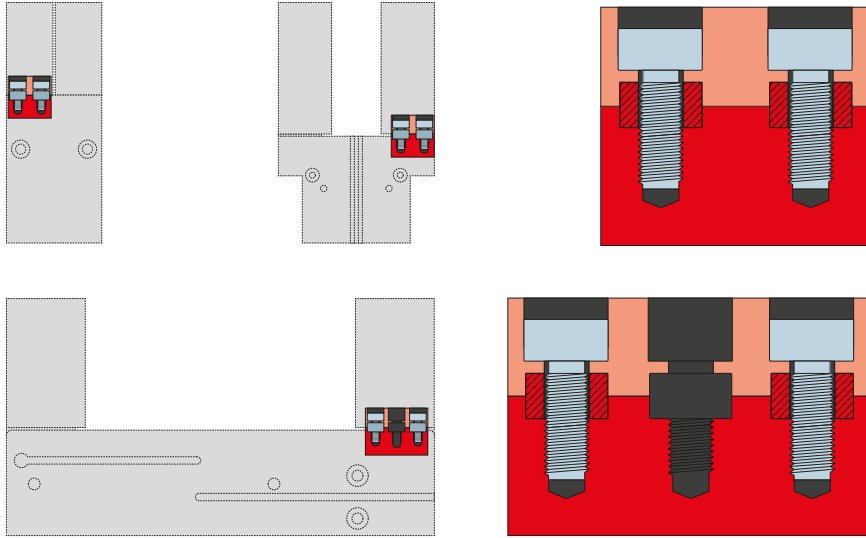

Centering sleeves

For defined position measurement of the gripper fingers

The centering sleeves are inserted into the fits of the gripper jaws to define the position of the gripper fingers. The centering sleeves are comparable to a pin connection.

2-JAW PARALLEL GRIPPERS WITH LONG STROKE

SERIES GH6000 GRIPPER FINGER LENGTH



MAXIMUM GRIPPER FINGER LENGTH

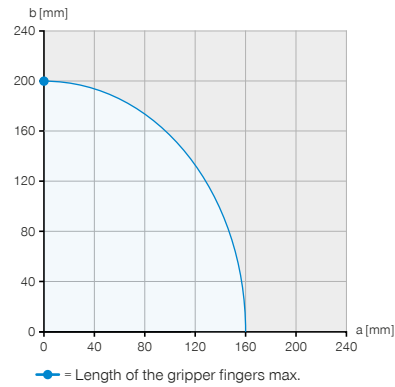
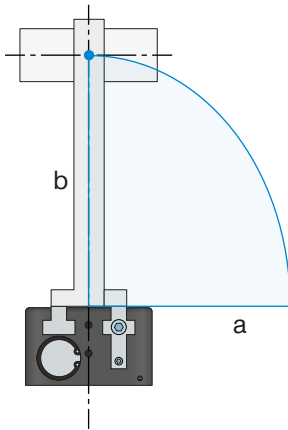

Example 1

Vertical force application point

$a = 0 \text{ mm}$

$b = 200 \text{ mm}$

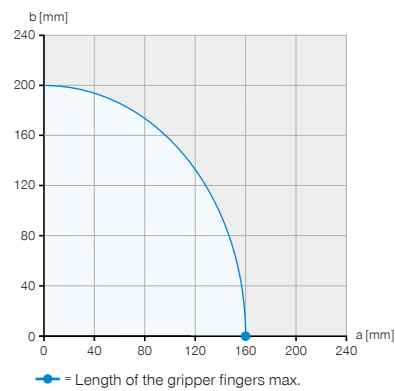
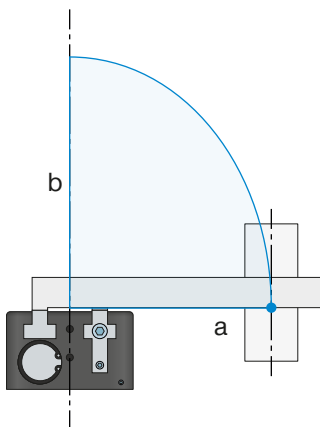

Example 2

Horizontal force application point

$a = 160 \text{ mm}$

$b = 0 \text{ mm}$

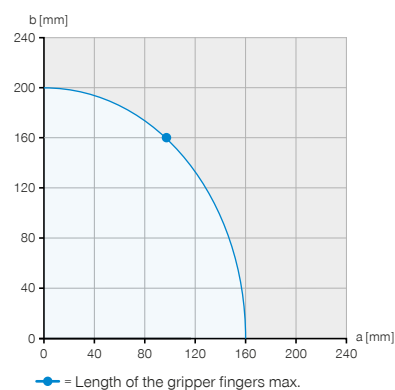
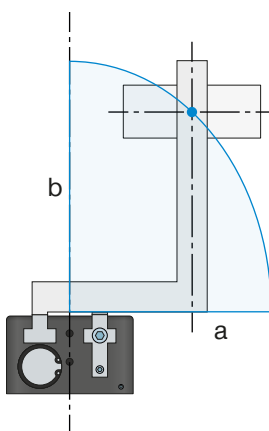

Example 3

Maximum permissible projection

$a = 96 \text{ mm}$

$b = 160 \text{ mm}$

The examples show the maximum horizontal (a) and vertical (b) gripper finger length using the example of a GH6140-B, which is represented by the blue area.



GRIPPING FORCE AS A FUNCTION OF GRIPPER FINGER LENGTH

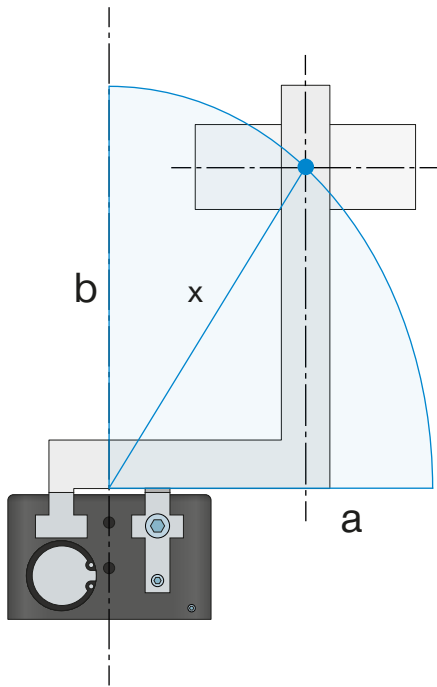

► Gripping force diagram

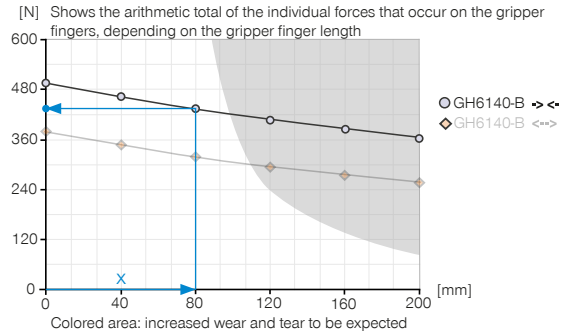

Example 4

Resulting gripper finger length for determining the gripping force

$a = 55 \text{ mm}$

$b = 58 \text{ mm}$

$$x = \sqrt{55^2 + 58^2} = 80 \Rightarrow 435 \text{ N}$$



The specified maximum gripper jaw length in the gripper technical data refers to a vertical (b) alignment of the gripper jaws. With a horizontal (a) overhang, the maximum gripper jaw length is reduced accordingly. The table shows the maximum gripper jaw lengths of the individual sizes.

If the required gripper jaw length lies within the tinted area of the gripping force diagram, increased wear must be expected - possibly reduce pressure.

► TECHNICAL DATA

Installation size	Permissible weight per jaw max	Length of the gripper fingers max. vertical (b)	Length of the gripper fingers max. horizontal (a)
	[kg]	[mm]	[mm]
GH6000	0.3	150	120
GH6100	1	200	160
GH6200	2.5	250	200
GH6300	3.5	300	240
GH6400	6	400	320