

2-JAW PARALLEL GRIPPERS

SERIES MGP800





▶ PRODUCT ADVANTAGES



“The powerful”

- ▶ **Over 40% more powerful than the benchmark**
Optimisation of weight and force reduces your application costs since all components can have a smaller scale
- ▶ **Gripper jaws up to 50% longer than the benchmark**
The highest force and torque measurement enables flexible use for maximum dynamics
- ▶ **Failure-free continuous operation**
Our uncompromising “Made in Germany” quality guarantees up to 10 million maintenance-free cycles

▶ SERIES CHARACTERISTICS

Installation size	Version	
MGP8XX	N	NC
 Spring closing C		●
 10 million maintenance-free cycles (max.)	●	●
 Magnetic field sensor	●	●
 IP40	●	●



► BENEFITS IN DETAIL

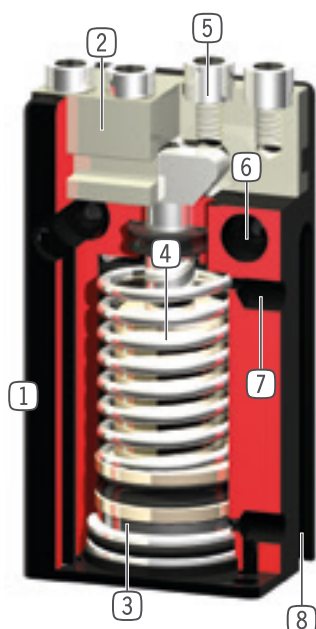

- ① **Robust, lightweight housing**
- Hard-coated aluminum alloy
- ② **Gripper jaw**
- individual gripper finger mounting
- ③ **Position sensing**
- permanent magnet for direct monitoring of piston movement
- ④ **Integrated gripping force safety device**
- spring integrated into cylinder as energy storage (from size 803 upwards)
- ⑤ **Removable centering sleeves**
- quick and economical positioning of the gripper fingers
- ⑥ **Mounting and positioning**
- mounting possible from several sides for versatile positioning
- ⑦ **Energy supply**
- possible from several sides
- ⑧ **Sensing slot**
- mounting and positioning of magnetic field sensors

► TECHNICAL DATA

Installation size	Stroke per jaw [mm]	Gripping force [N]	Weight [kg]	IP class
MGP801	1	6 - 8	0,008	IP40
MGP802	2	16 - 19	0,016	IP40
MGP803	3	35 - 55	0,025 - 0,035	IP40
MGP804	4	60 - 90	0,05 - 0,07	IP40
MGP806	6	100 - 140	0,1 - 0,11	IP40
MGP808	8	170 - 220	0,16 - 0,18	IP40
MGP810	10	270 - 350	0,28 - 0,32	IP40
MGP812	12	320 - 400	0,41 - 0,46	IP40

► FURTHER INFORMATION IS AVAILABLE ONLINE



All information just a click away at: www.zimmer-group.com. Find data, illustrations, 3D models and operating instructions for your installation size using the order number for your desired product. Quick, clear and always up-to-date.

2-JAW PARALLEL GRIPPERS

INSTALLATION SIZE MGP804

▶ PRODUCT SPECIFICATIONS



▶ Gripping force diagram

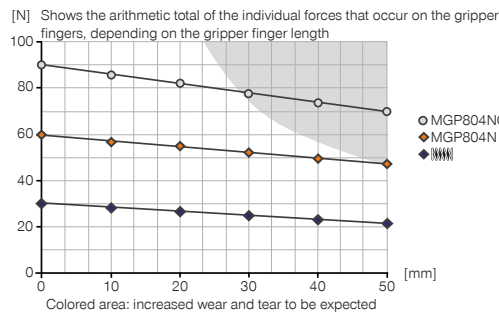

▶ Forces and moments

Displays static forces and moments that can also have an effect, besides the gripping force.



Mr [Nm]	3
Mx [Nm]	7
My [Nm]	3
Fa [N]	230

▶ INCLUDED IN DELIVERY



4 [piece]
Centering Disc
DST40400

▶ RECOMMENDED ACCESSORIES



ENERGY SUPPLY



GVM3
Straight Fittings - Barb Style Connection



WVM3
Angled Fittings - Barb Style Connection



DEV04
Quick Exhaust Valve



SENSORS



MFS02-S-KHC-P1-PNP
Magnetic field sensor straight, cable 0.3 m - M8 connector



MFS01-S-KHC-P2-PNP
2-point sensor angled, cable 0.3 m - M8 connector



MFS02-S-KHC-P2-PNP
2-point sensor straight, cable 0.3 m - M8 connector



SENSORS



MFS01-S-KHC-P1-PNP
Magnetic field sensor angled, cable 0.3 m - M8 connector



CONNECTIONS / OTHER



KAG500
Plug-in connector Straight Cable 5m - Socket M8 (female)

2-JAW PARALLEL GRIPPERS

SERIES MGP800 FUNCTIONAL DESCRIPTION



ENERGY SUPPLY

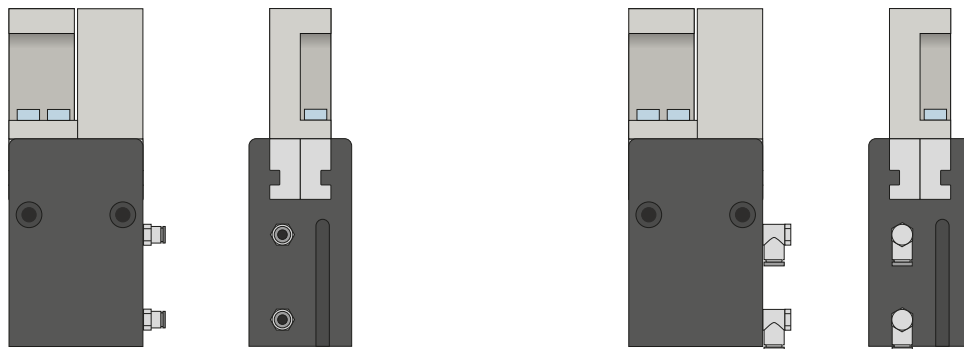

Pneumatic threaded connections

Available in straight and angled design. Can be chosen freely depending on the space conditions or installation situation.

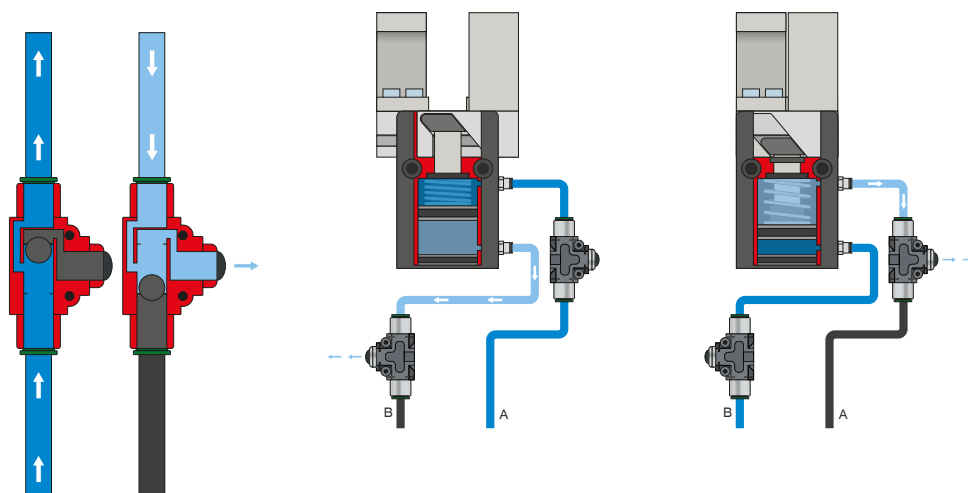

Quick exhaust valve – DEV

For rapid bleeding of the compressed air and preventing back pressure

The inline valves make a faster cycle time possible and prevent the formation of condensate in grippers with a small cylinder volume. To ensure the function, the valve must be installed as close to the gripper's air connection as possible.



SENSORS

MFS02

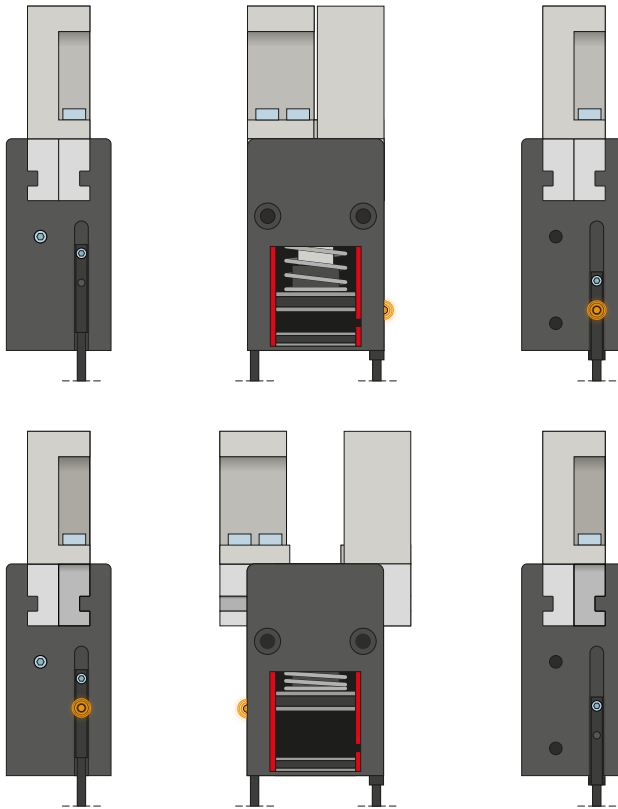

MFS01

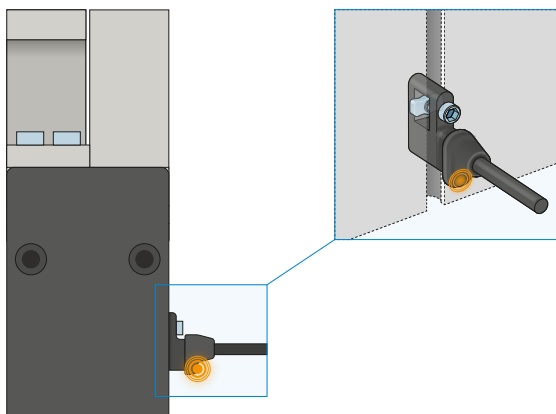

1-point magnetic field sensors – MFS

For non-contact sensing of the piston position

These sensors are installed in the C-groove of the gripper and detect the magnet attached to the piston of the gripper. To ensure use in a wide variety of space conditions, the sensors are available in two variants. While the horizontal MFS02, with straight cable outlet, disappears into the C-groove of the gripper almost completely, the vertical MFS01 is taller, but has a cable outlet that is offset at an angle of 90°. The variants are available in versions with 5 m cables with exposed leads and 0,3 m cable with connector.

2-JAW PARALLEL GRIPPERS

SERIES MGP800 FUNCTIONAL DESCRIPTION



SENSORS

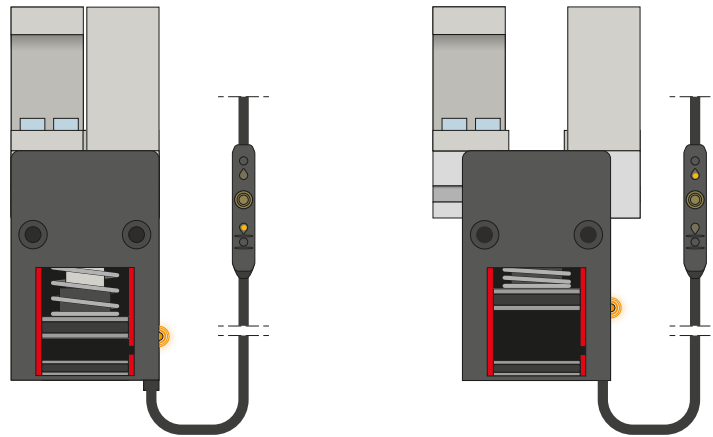

2-point magnetic field sensors - MFS

With two freely programmable switching points

Using the programming unit integrated in the cable, two switch points can be freely defined for this sensor. To do so, the sensor is clamped in the C-groove, the gripper approaches position one and the position is taught in using the teach button. Afterwards, the second position is approached with the gripper and programmed. To ensure use in a wide variety of space conditions, the sensors are available in two variants. While the horizontal MFS02, with straight cable outlet, disappears into the C-groove of the gripper almost completely, the vertical MFS01 is taller, but has a cable outlet that is offset at an angle of 90°. The sensors are available in versions with 5 m cables with exposed leads and 0,3 m cable with connector.



CONNECTIONS / OTHER

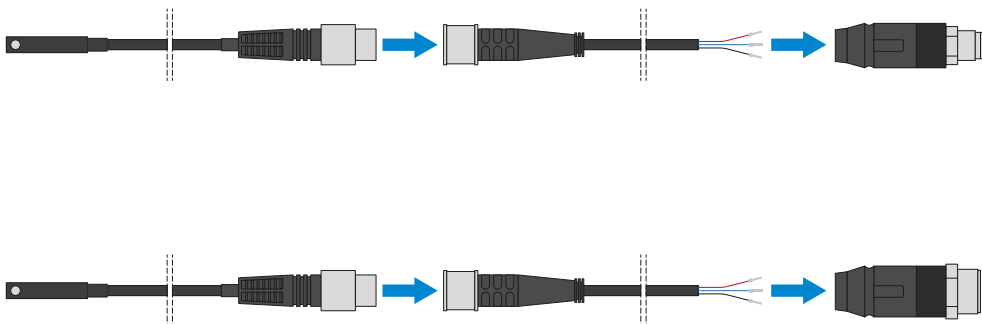

Plug-in connectors

For extending and fabricating the connection lines for the sensors

Cables with a length of 5 m with exposed leads are available. Depending on the specific needs, the cables can be shortened or fabricated with connectors in sizes M8 and M12.



CONNECTIONS / OTHER

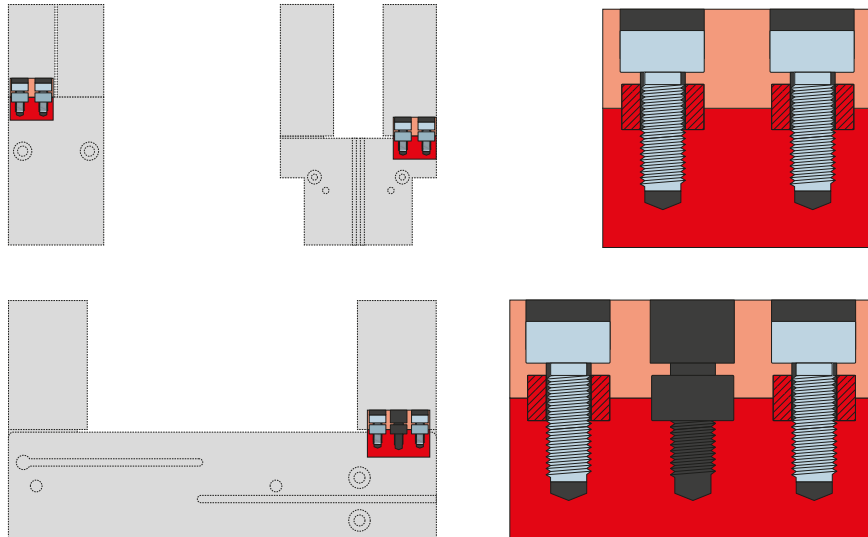

Centering sleeves

For defined position measurement of the gripper fingers

The centering sleeves are inserted into the fits of the gripper jaws to define the position of the gripper fingers. The centering sleeves are comparable to a pin connection.